

Safety distances

ME CEILING STOVE WITH DV KIT

 Nordpeis

FIG 1 = MM

ME CEILING - STOVE

 = Brennbart materiale/ Brännbart material/ Combustible material/ Palavasta materiaalista/ Brennbares Material/ Matières combustibles

ME stove with side glass

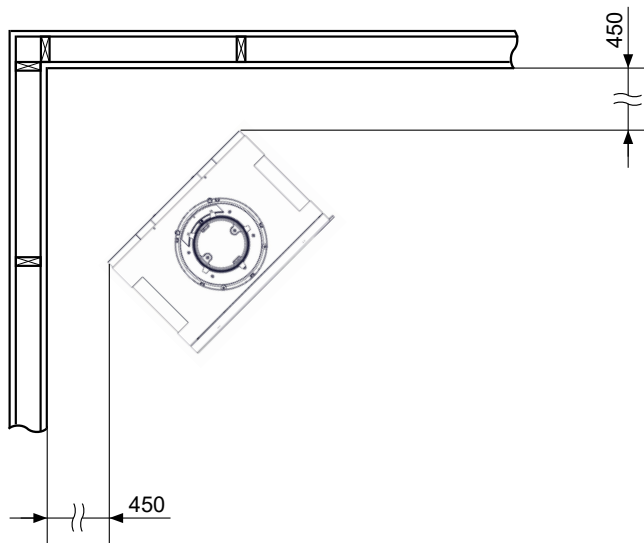

ME stove without side glass

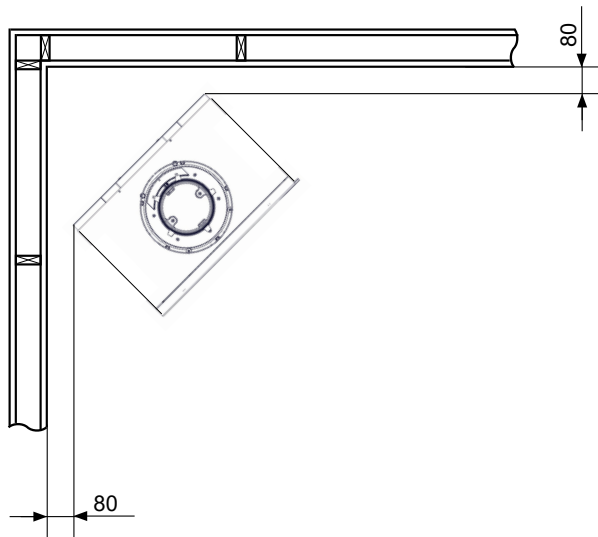



Safety distances

ME CEILING STOVE WITH DV KIT

 Nordpeis

FIG 2 = MM

ME CEILING - STOVE WITH SIDEGLASS

-  = Brannmur/ Brandmur/ Firewall/ Palomuri/ Hitzeschutzwand/ Mur pare feu
-  = Brennbar materiale/ Brännbart material/ Combustible material/ Palavasta materiaalista/ Brennbares Material/ Matières combustibles

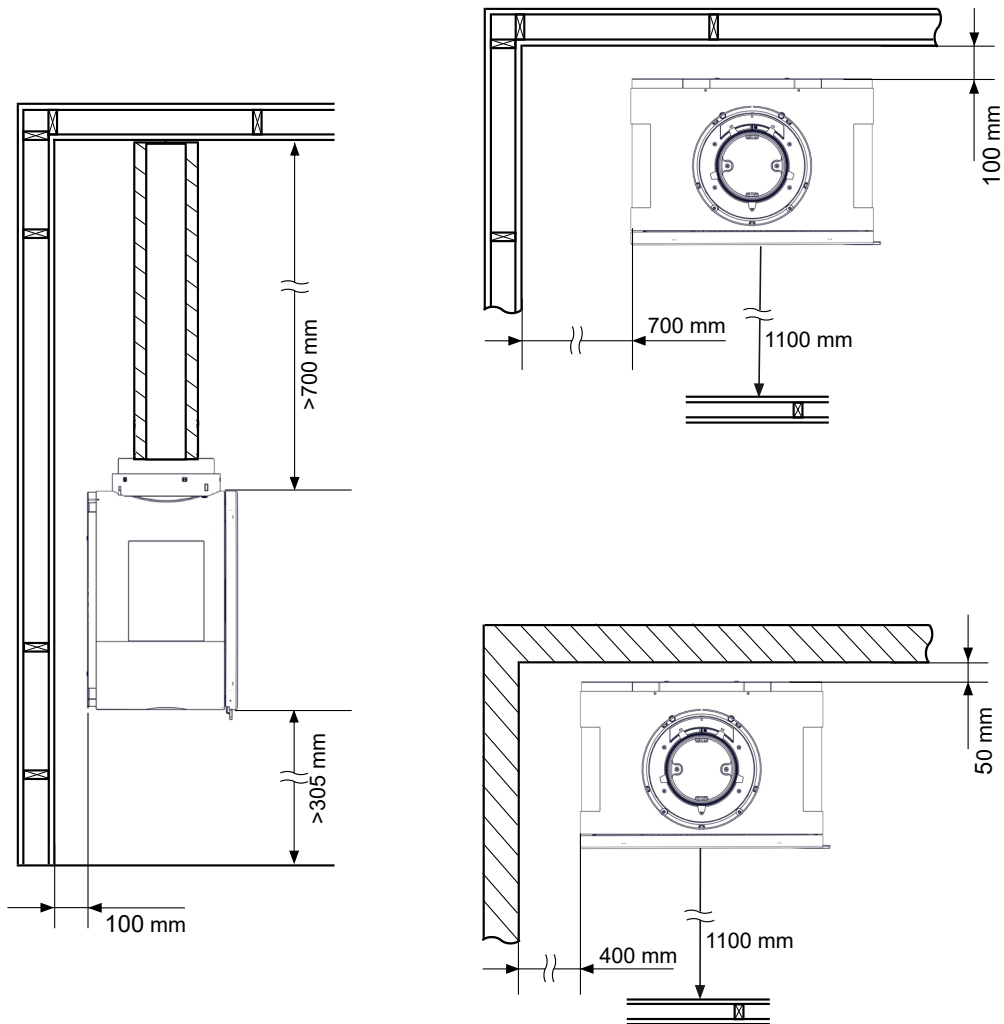

Safety distances

ME CEILING STOVE WITH DV KIT

 Nordpeis

FIG 3 = MM

ME CEILING - STOVE W/O SIDEGLASS

 = Brannmur/ Brandmur/ Firewall/ Palomuri/ Hitzenschutzwand/ Mur pare feu

 = Brennbar materiale/ Brännbart material/ Combustible material/ Palavasta materiaalista/ Brennbare Material/ Matières combustibles

